

Field Guide for Installation of Flanged Ductile Iron Pipe

1. Thoroughly check all flanged ductile iron spools when they are received at the job site to ensure there has been no damage to the lining, coating, or the ends of the pipe as a result of shipping. If there has been any damage take pictures and send immediately to your supplier.
 - a. All flanged pipe should be lifted by use of a pallet or sling and not the flanged end as this could potentially result in breaking the watertight thread seal of the flanged joint. Proper and safe handling is critical as any impact such as dropping may damage this seal as well.
 - b. Inserting or lifting the flanged pipe by using the forks of a forklift is not acceptable and will damage the lining. If the lining is damaged or compromised, then it must be properly repaired before the flanged pipe is installed and placed into service.
 - c. The flanged face must be checked before installation to make sure it is clean and free of debris. The rust preventative coating the flange face should be removed with solvent or wire brush.
2. The accepted industry protocol on gasket use for flanged ductile iron pipe, as written in the ANSA/AWWA C115/A21.15, Appendix A states “Unless otherwise specified by the purchaser, gaskets shall be synthetic rubber, either ring or full face, and 1/8” (3.18 mm) thick. Gaskets should conform to the dimension shown in Table A.1/AWWA C115. When considering the use of gaskets thinner than 1/8” (3.18mm) and/or gaskets of materials other than synthetic rubber, the purchaser should contact the pipe manufacturer or fabricator concerning such gaskets’ suitability for a particular application. Also available in most sizes are the specially designed gaskets, either ring or full faced employing one or more annular rings molded into the gasket to improve joint performance. By the use of these or other special gaskets it may be possible to obtain a pressure rating greater than 250 psi (1,720kPA). Contact the pipe manufacturer or fabricator for details.”
3. Recommendations for the bolts to be used for installation of flanged ductile iron pipe have also been made by the AWWA. The recommended size, length, and number of bolts are shown in Table 2 and 3 of ANSI/AWWA C115/A21.15. Bolts are to conform to ANSI/ASME B18.2.1, Square and Hex bolts and Screws Inch Series including Hex Cap Screws and Lag Screws. Nuts are to conform to ANSI/ASME B18.2.2, Square and Hex Nuts Inch Series. Bolts and nuts used with gray-iron flanges should have standard square or heavy hex bolts and heavy hex nuts. Bolts and nuts are threaded in accordance with ASME/ANSI B1.1, Unified inch screw threads (UN and UNR thread form), class 2A, external and class 2B, internal. Bolts and nuts of low carbon steel conforming to the chemical and mechanical requirements so ASTM A307, standard specification for the carbon steel bolts and studs, 60,000 psi Tensile Strength are suitable for use with the flanges described in ANSI/AWWA C115/A21.15 when used with the rubber gaskets described. Higher strength (Grade A) bolts and higher torque values should not be used with gray-iron flanges.
4. The AWWA also states, “The purchaser is responsible for the design, assembly and installation of flanged piping system.” The following suggestion are for general guidance:
 - a. The use of flanged joints underground is generally not recommended because of the rigidity of the joint. It should be noted that because of the extremely limited availability and long lead times associated with MJ Bell pipe, MJ threaded adapt-a-bell can be an

Field Guide for Installation of Flanged Ductile Iron Pipe

alternative. However, these are not recommended for underground service. It is strongly recommended to use restrained joint pipe, or push-on pipe with field locking gaskets as an alternative for underground applications.

- b. Due to the nature of aerial crossings, it is strongly recommended to use flex joint pipe and a properly engineered support system.
- c. Flanged faces should bear uniformly on the gasket, and the bolts should be tightened in a progressively crisscrossed pattern. (See the attached Bolt Torque Procedure).
- d. The use of a torque wrench is critical when bolting flanged ductile iron pipe. (See attached Torque Values table).

Suggested Torque Values (Ft. Lbs.)

Standard Ductile Iron 125# Flange, Grade 2 Nut and Bolt with Flat Washer, Dry Assembly

Pipe Size (inches)	Bolt Diameter (inches)	Full Face (RR or Neo.) Minimum (Per IFI 100/107-1987)	Toruseal Minimum (Per ACIPCO)	Flange-Type Minimum (Per U.S. Pipe)
3	5/8	100		
4	5/8	100	100	90
6	3/4	175	150	90
8	3/4	175	150	90
10	7/8	200	200	90
12	7/8	200	200	90
14	1	250	250	110
16	1	250	250	110
18	1 1/8	350	300	120
20	1 1/8	350	300	120
24	1 1/4	500	400	130
30	1 1/4	500	400	140
36	1 1/2	870	500	160
42	1 1/2	870	500	585
48	1 1/2	870	500	625
54	1 3/4		600	550*
60	1 3/4		600	600*
64	1 3/4		600	600*

* 150 PSI working

It is recommended that torque be applied in increments of one fifth (1/5) of the total torque required.

This information has been compiled from various technical references

Bolt Torque Procedure

Procedure for Application

Bolt Torque on Flanged Joints

1. Align component part and clamp together with hold down.
2. Lubricate stud (or bolt) threads in area of nut (or forged ring) engagement, also lubricate face of nuts (or bolt head) using a suitable lubricant.
3. Install all bolts and nuts finger tight.
4. Number bolts so that torquing requirements can be followed.
5. Apply torque in 20% (1/5) steps of required final torque, loading all bolts at each step before proceeding to next step.
6. Tighten bolts in sequential order 0-180°, 90°-270°, 45°-225°, 135°-315°, at each step until final torque is reached.
7. Use rotational tightening until all bolts are stable at final torque level (two complete times around is usually required).

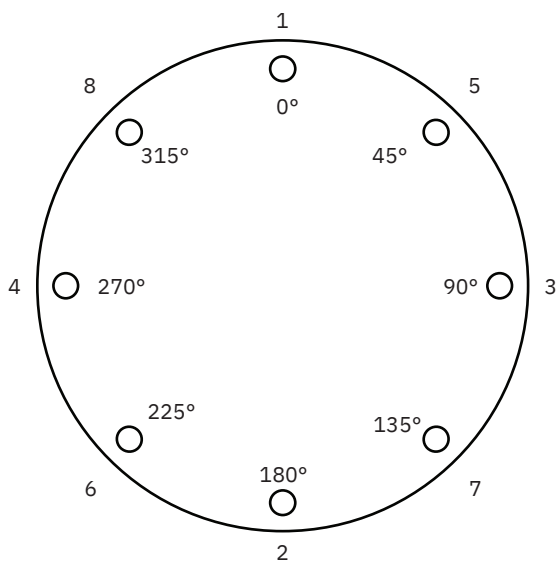

8-Bolts

Sequential Order

- 1-2
- 3-4
- 5-6
- 7-8

Rotational Order

- 1
- 5
- 3
- 7
- 2
- 6
- 4
- 8

Field Guide for Installation of Flanged Ductile Iron Pipe

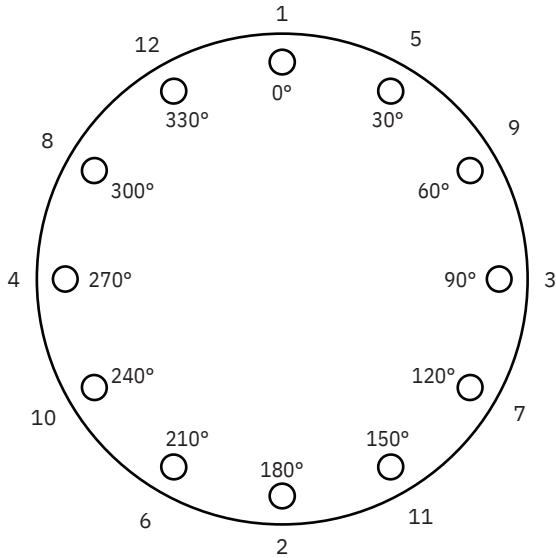

12-Bolts

Sequential Order

- 1-2
- 3-4
- 5-6
- 7-8
- 9-10
- 11-12

Rotational Order

- | | |
|----|----|
| 1 | 2 |
| 5 | 6 |
| 9 | 10 |
| 3 | 4 |
| 7 | 8 |
| 11 | 12 |

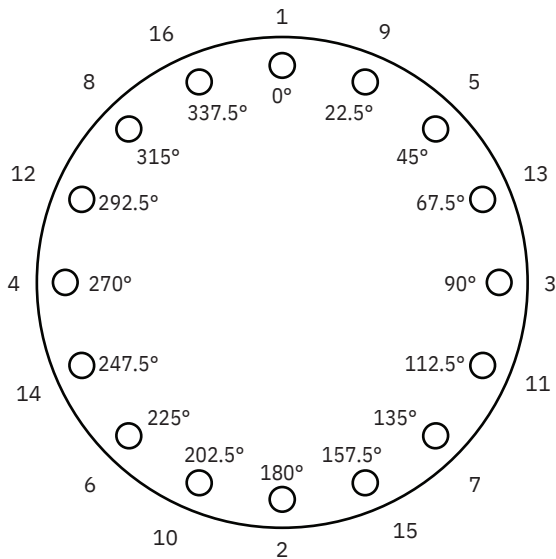

16-Bolts

Sequential Order

- 1-2
- 3-4
- 5-6
- 7-8
- 9-10
- 11-12
- 13-14
- 15-16

Rotational Order

- | | |
|----|----|
| 1 | 2 |
| 9 | 10 |
| 5 | 6 |
| 13 | 14 |
| 3 | 4 |
| 11 | 12 |
| 7 | 8 |
| 15 | 16 |

Field Guide for Installation of Flanged Ductile Iron Pipe

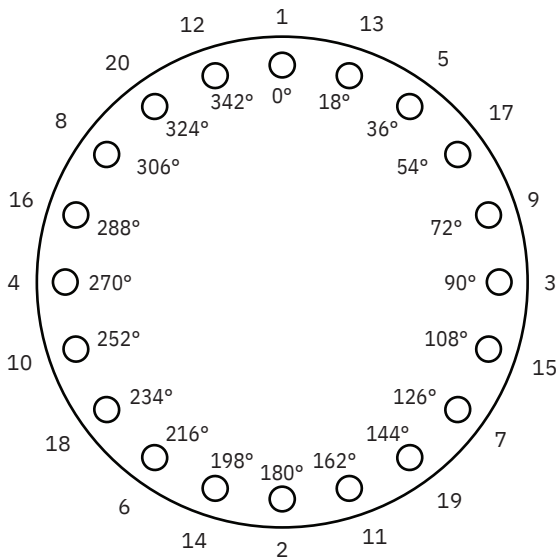

20-Bolts

Sequential Order

- 1-2
- 3-4
- 5-6
- 7-8
- 9-10
- 11-12
- 13-14
- 15-16
- 17-18
- 19-20

Rotational Order

- | | |
|----|----|
| 1 | 2 |
| 13 | 14 |
| 5 | 6 |
| 17 | 18 |
| 9 | 10 |
| 3 | 4 |
| 15 | 16 |
| 7 | 8 |
| 19 | 20 |
| 11 | 12 |

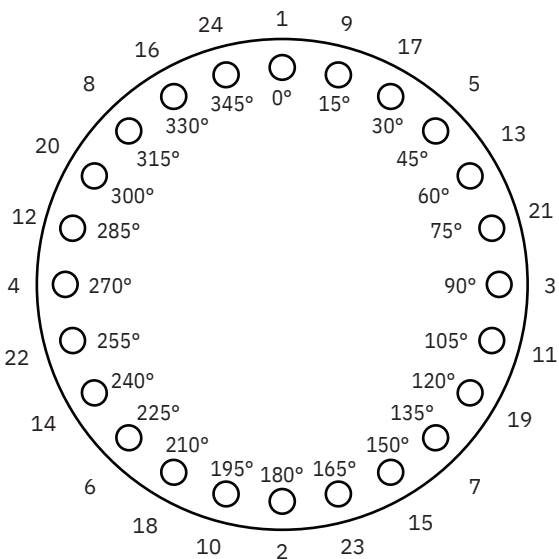

24-Bolts

Sequential Order

- | | |
|-------|-------|
| 1-2 | 13-14 |
| 3-4 | 15-16 |
| 5-6 | 17-18 |
| 7-8 | 19-20 |
| 9-10 | 21-22 |
| 11-12 | 23-24 |

Rotational Order

- | | |
|----|----|
| 1 | 2 |
| 9 | 10 |
| 17 | 18 |
| 5 | 6 |
| 13 | 14 |
| 21 | 22 |
| 3 | 4 |
| 11 | 12 |
| 19 | 20 |
| 7 | 8 |
| 15 | 16 |
| 23 | 24 |

Field Guide for Installation of Flanged Ductile Iron Pipe

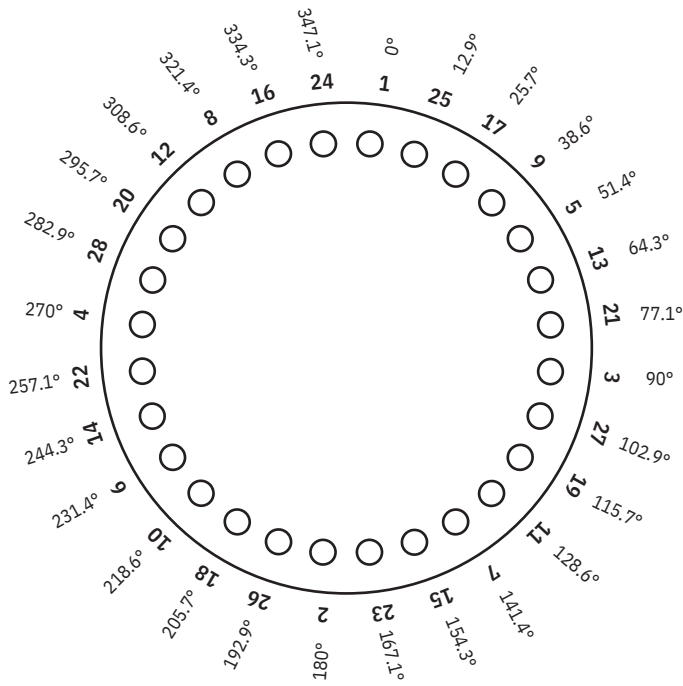

28-Bolts

Sequential Order

- 1-2
- 3-4
- 5-6
- 7-8
- 9-10
- 11-12
- 13-14
- 15-16
- 17-18
- 19-20
- 21-22
- 23-24
- 25-26
- 27-28

Rotational Order

- 1
- 25
- 17
- 9
- 5
- 13
- 21
- 3
- 27
- 19
- 11
- 7
- 15
- 23
- 2
- 26
- 18
- 10
- 6
- 14
- 22
- 4
- 28
- 20
- 12
- 8
- 16
- 24

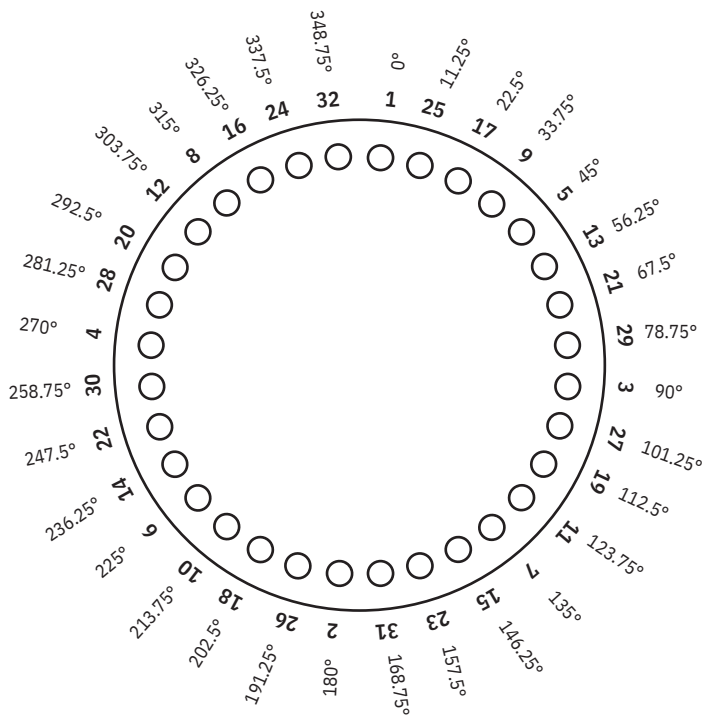

32-Bolts

Sequential Order

- 1-2
- 3-4
- 5-6
- 7-8
- 9-10
- 11-12
- 13-14
- 15-16
- 17-18
- 19-20
- 21-22
- 23-24
- 25-26
- 27-28
- 29-30
- 31-32

Rotational Order

- 1
- 25
- 17
- 9
- 5
- 13
- 21
- 3
- 27
- 19
- 11
- 7
- 15
- 23
- 31
- 2
- 26
- 18
- 10
- 6
- 14
- 22
- 4
- 28
- 20
- 12
- 8
- 16
- 24
- 32

36-Bolts

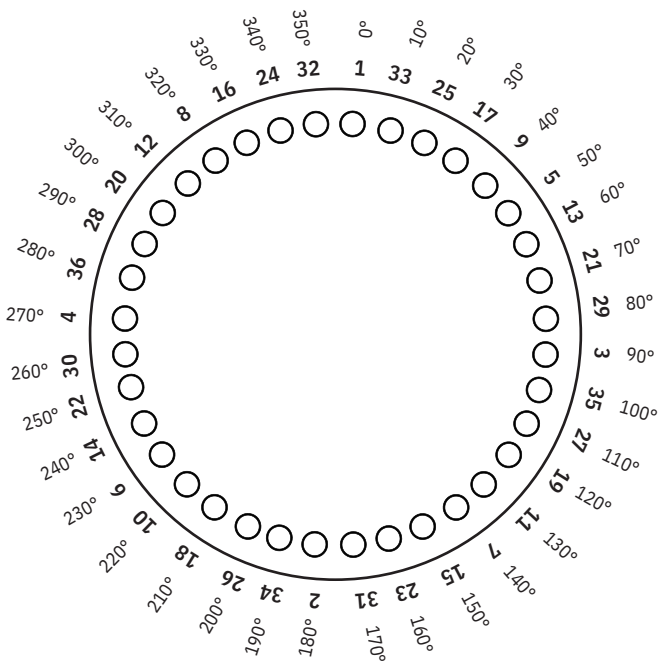

Sequential Order

- 1-2
- 3-4
- 5-6
- 7-8
- 9-10
- 11-12
- 13-14
- 15-16
- 17-18
- 19-20
- 21-22
- 23-24
- 25-26
- 27-28
- 29-30
- 31-32
- 33-34
- 35-36

Rotational Order

- 1
- 33
- 25
- 17
- 9
- 5
- 13
- 21
- 29
- 3
- 35
- 27
- 19
- 11
- 7
- 15
- 23
- 31
- 2
- 34
- 26
- 18
- 10
- 6
- 14
- 22
- 30
- 4
- 36
- 28
- 20
- 12
- 8
- 16
- 24
- 32

44-Bolts

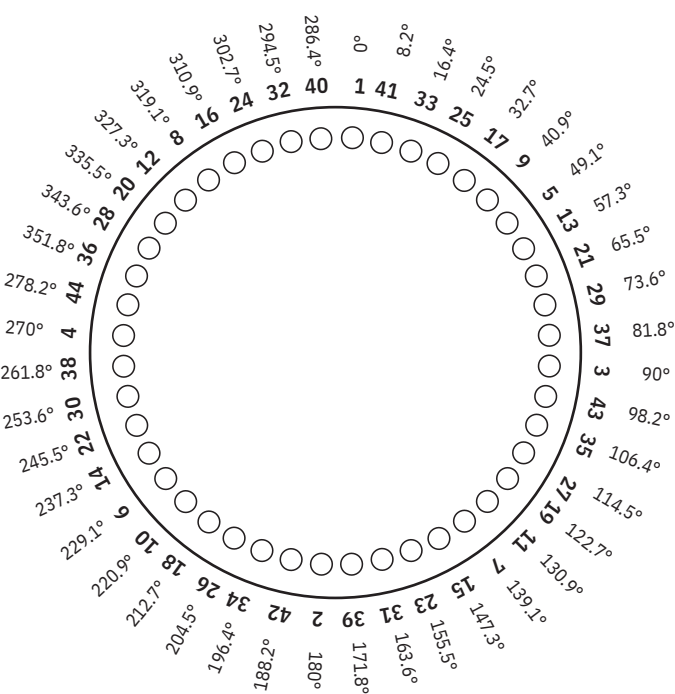

Sequential Order

- 1-2
- 3-4
- 5-6
- 7-8
- 9-10
- 11-12
- 13-14
- 15-16
- 17-18
- 19-20
- 21-22
- 23-24
- 25-26
- 27-28
- 29-30
- 31-32
- 33-34
- 35-36
- 37-38
- 39-40
- 41-42
- 43-44

Rotational Order

- 1
- 41
- 33
- 25
- 17
- 9
- 5
- 13
- 21
- 29
- 37
- 3
- 43
- 35
- 27
- 19
- 11
- 7
- 15
- 23
- 31
- 39
- 2
- 42
- 34
- 26
- 18
- 10
- 6
- 14
- 22
- 30
- 38
- 4
- 44
- 36
- 28
- 20
- 12
- 8
- 16
- 24
- 32
- 40

Field Guide for Installation of Flanged Ductile Iron Pipe

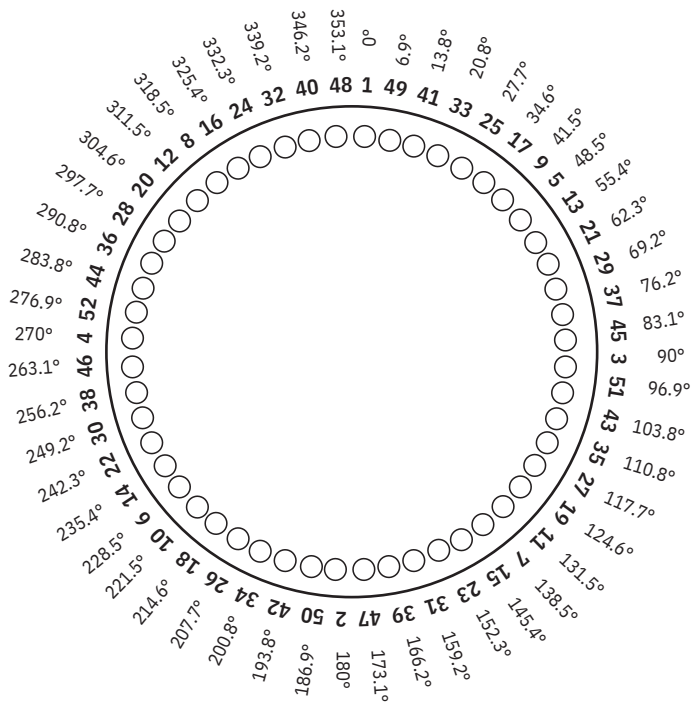

52-Bolts

Sequential Order

- 1-2
- 3-4
- 5-6
- 7-8
- 9-10
- 11-12
- 13-14
- 15-16
- 17-18
- 19-20
- 21-22
- 23-24
- 25-26
- 27-28
- 29-30
- 31-32
- 33-34
- 35-36
- 37-38
- 39-40
- 41-42
- 43-44
- 45-46
- 47-48
- 49-50
- 51-52

Rotational Order

- 1
- 49
- 41
- 33
- 25
- 17
- 9
- 5
- 13
- 21
- 29
- 37
- 45
- 3
- 51
- 43
- 35
- 27
- 19
- 11
- 7
- 15
- 23
- 31
- 39
- 47
- 2
- 50
- 42
- 34
- 26
- 18
- 10
- 6
- 14
- 22
- 30
- 38
- 46
- 4
- 52
- 44
- 36
- 28
- 20
- 12
- 8
- 16
- 24
- 32
- 40